

Ascent 100 II

IS2017E

Ascent 100 - Sml 120
Ascent 100 - Lrg 160

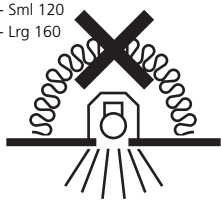

230-240V~ 50-60Hz



620 x 440 x 150 Min.

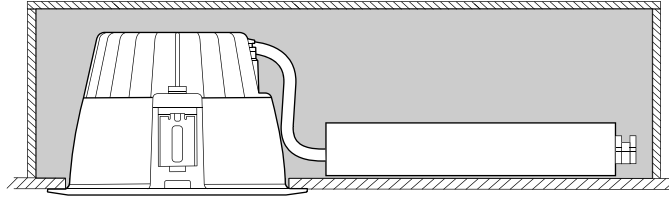

1

i Ascent 100 - Sml 120

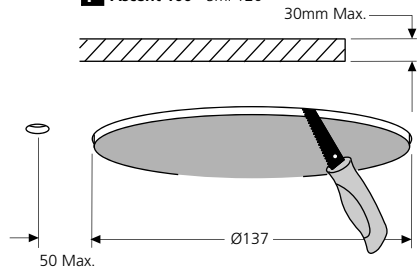

ii Ascent 100 - Lrg 160

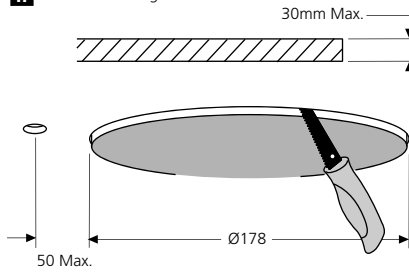

2

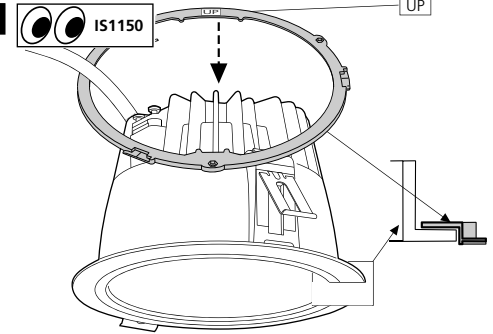

2

220-240V~ 2(6 Max.) x 0.75mm² Min.

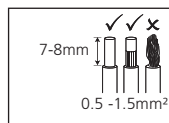
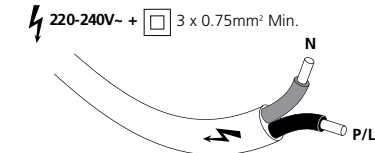
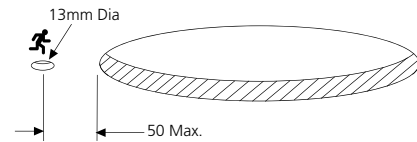

220-240V~ + DALI

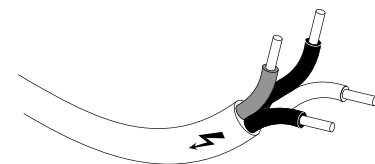

3a

220-240V~ +

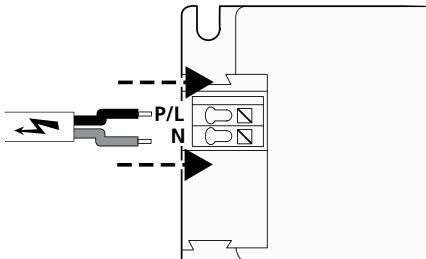

3b

220-240V~ + DALI

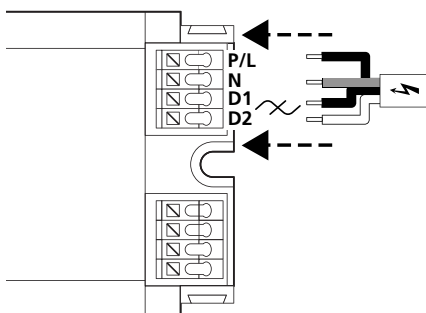

3c

220-240V~ + DALI + PRO

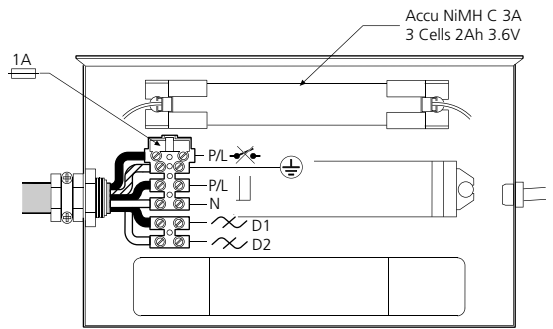

4

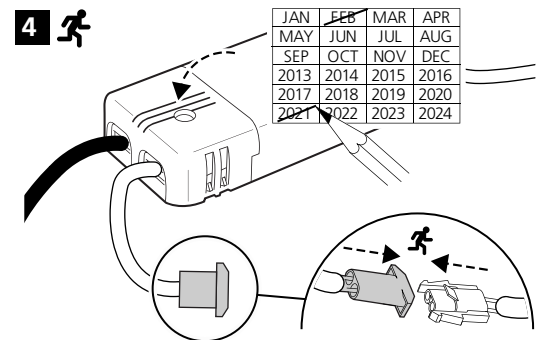

i

LED

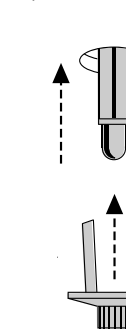

ii

